

# Smart Building Control Systems by GVS :

KNX/EIB System

Video Intercom System



## Catalogue

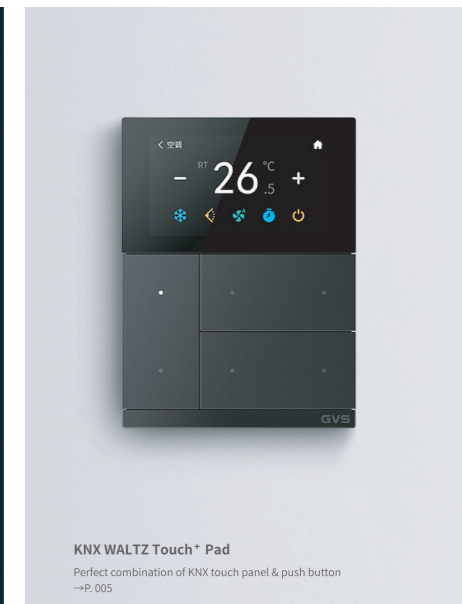

**Guangzhou Video-Star Intelligent Corp.,Ltd**



Tel: +86 20 82088388  
Fax: +86 20 82088238  
www.gvssmart.com  
info@gvssmart.com

F3 / Building#5, No. 9, 4th Lanyu St.,  
Huangpu District,Guangzhou, 510730,  
P. R. China

## GVS Since 1999

Established in 1999, GVS is a high-tech company which has its own professional team for product R&D, manufacturing and sales activities. The company has been devoting itself into smart building technologies since its establishment and providing its clients with product and solution of Smart Building, Smart Security and Smart Healthcare. With its highlighted capability in display and building technology, the company has long been in the first rankings of suppliers for both KNX Building Control System as well as IP/2-Wire Video Intercom System. As the FIRST native BOARD MEMBER of KNX CHINA and first-ranking video intercom supplier, GVS will never cease to renovate and will continuously contribute to smart building technologies in the coming decades...

## Professional Manufactory

Facility & Equipment: modern factory with SMT, plug-in, assembling, testing lines; QC, electrical safety labs, high-low temperature aging room;

Standard & Certificate: ISO90001, QC080000, RoHS, CE, KNX, FCC.

Production Capacity (annually): TFT & display module 4.5M pcs, KNX device 300K pcs, video intercom device 400K pcs.



## Video Intercom Pathfinder

Dated back to 1999, GVS started with audio intercom module business, later developed to video intercom module. Started from analog 2-wire system, GVS now offers its client with full digital IP intercom solution, with perfect integration with smart home functions. GVS has never stopped on the way of exploration and innovation for a smarter and more secured life style.



## GVS - A company with history

In 1999	In 2008	In 2011	In 2013	In 2015	In 2017	In 2018	In 2019	In 2020	In 2021
GVS was established.	GVS became the first Chinese KNX member in China.	First KNX Training Center in China was established by GVS.	Initiator and Chairman of the drafting team for IEEE1888.4 Green Home & Building Automation.	GVS became the FIRST native council member of KNX China.	GVS became a public company by entering NEEQ (the New OTC).	GVS became the first native company who chaired KNX CHINA.	Smart healthcare business unit founded; meanwhile, a smart wifi thermostat business line Vine was created to explore the NA consumer electronics market.	Free assistance to over 30 clients worldwide during Covid-19. Survived and thrived with a 20% annual net growth. STAR Market Program launched.	GVS is ready to embrace the challenge and cooperate with you to create a smart and better life...

# Product Series

KNX Home & Building Control System  
P. 004 - P. 011

## KNX Home & Building Control System

### KNX Smart Home Solution

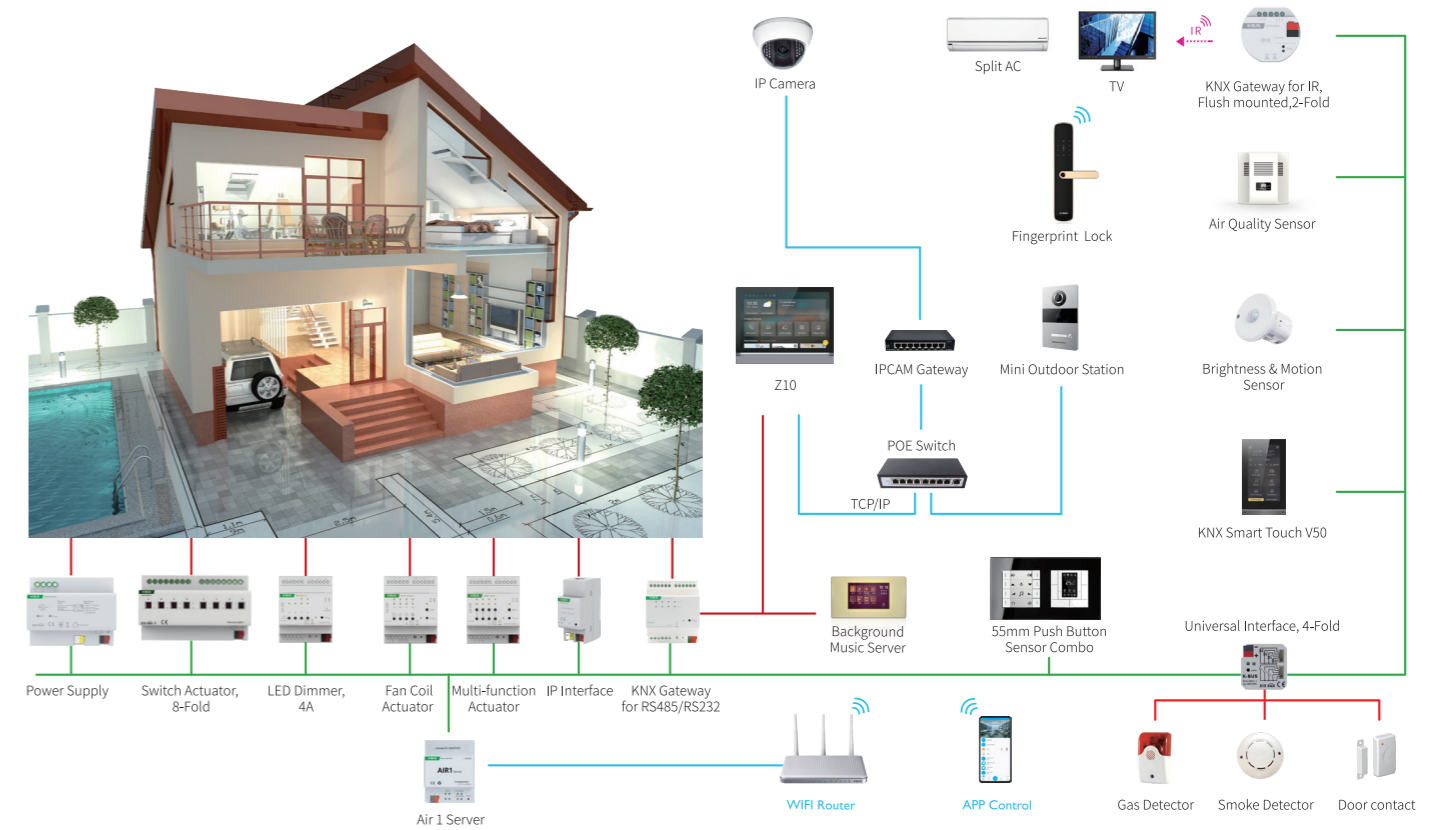

### KNX Smart Hotel Solution

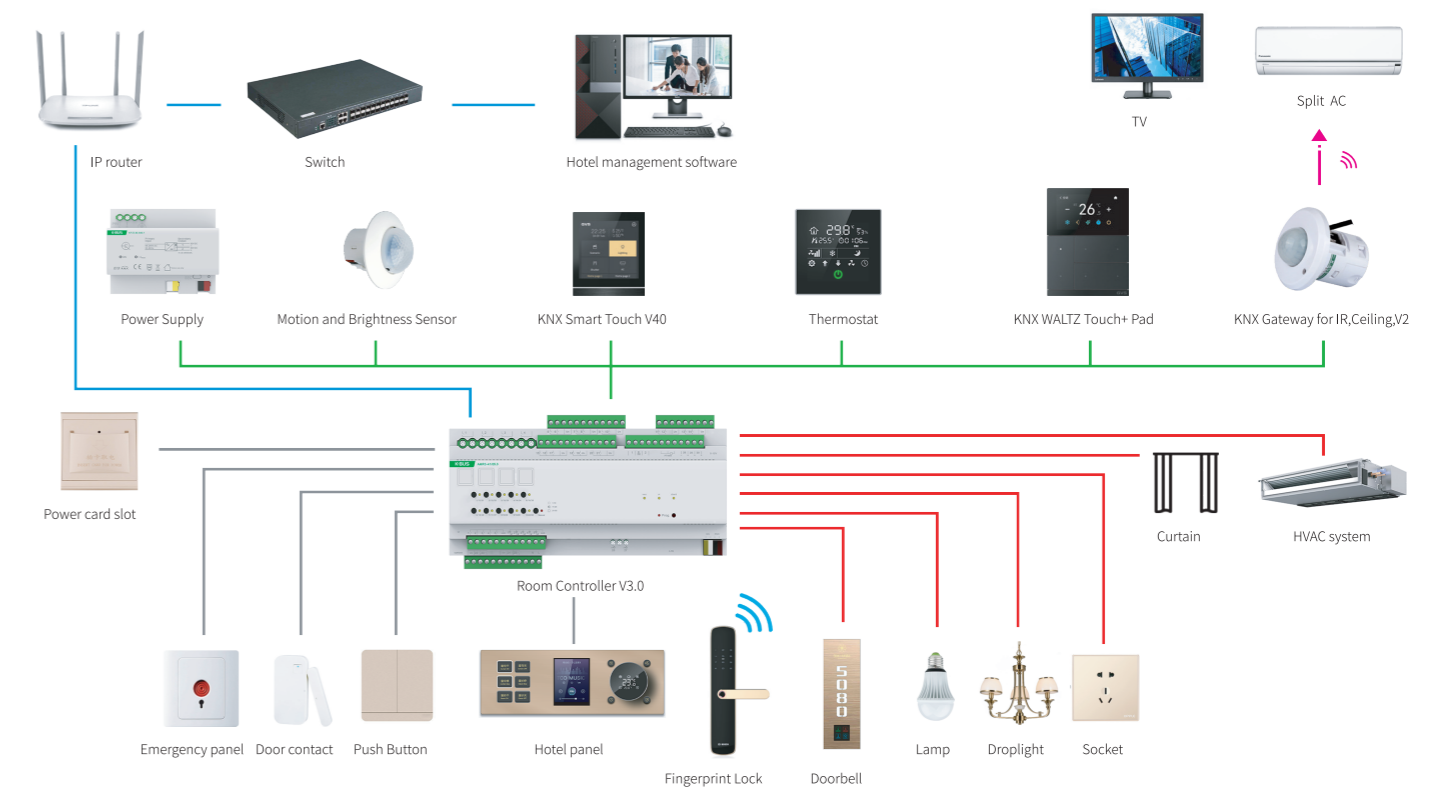



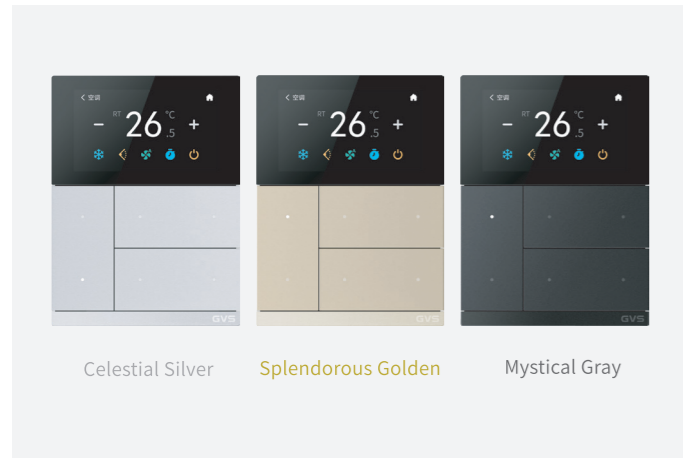

## KNX WALTZ Touch+ Pad

**NEW!**

Plastic: CHTFB-3.0/6.1.02  
 CHTFB-3.0/6.1.03  
 CHTFB-3.0/6.1.04  
 Metal: CHTFB-3.0/6.1.22  
 CHTFB-3.0/6.1.23  
 CHTFB-3.0/6.1.24

### Function:

- Elegant design mixed with IPS capacitive touch panel & mechanical button
- Aluminum frame and replaceable buttons (plastic/aluminum)
- Synchronized animation effects on display when buttons pressed
- Push Buttons adjustable for 1 or 2 button operation
- Built-in temperature sensor, RGB status LED indication
- Adjustable for button push length, NO or NC contact operation
- Short/long operation for KNX functions of lighting, scene control, shutter etc.
- Supporting ring included for installation, integrated bus coupling unit
- 3 years' warranty, 3 classic colors available

## KNX WALTZ Push Button Pro **Coming soon...**

Plastic: CHPBV-02/02.1.0x  
 CHPB-04/02.1.0x  
 CHPB-06/02.1.0x  
 CHPB-08/02.1.0x  
 Metal: CHPBV-02/02.1.2x (x=2, 3, 4: colors)  
 CHPB-04/02.1.2x  
 CHPB-06/02.1.2x  
 CHPB-08/02.1.2x

### Function:

- Latest elegant KNX push buttons for WALTZ Series
- Push Buttons adjustable for 1 or 2 button operation
- Aluminum frame and buttons of plastic/aluminum and 3-color options
- Built-in voice control and temperature sensor, with LED indication
- Adjustable for button push length, NO or NC contact operation
- Short/long operation for KNX functions of lighting, scene control, shutter etc.
- Supporting ring included for installation, integrated bus coupling unit
- 3 years' warranty

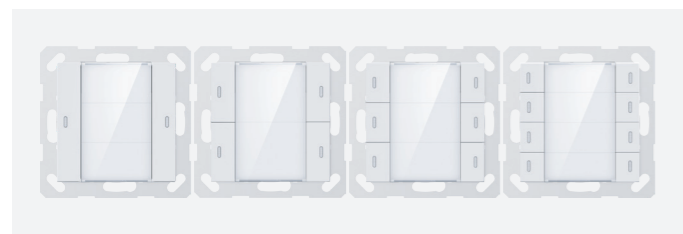
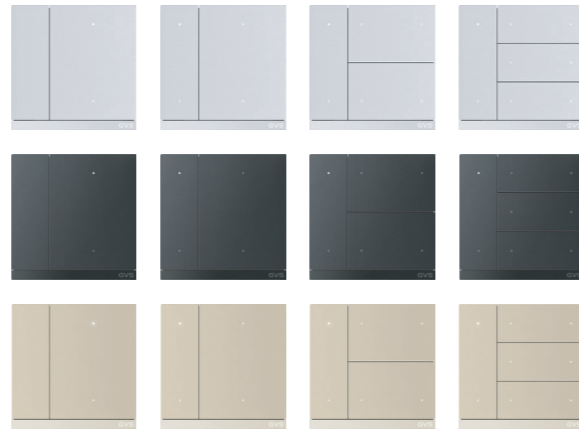

## KNX Push Button Sensor Plus, 55mm

CHPLE-0x/02.y.00  
 (x=1, 2, 3, 4 means 1~4-fold buttons); (y=1, 2 means shiny/matt finish)

### Function:

- 100% fits 55mm systems:
  - GIRA Standard 55, E2, E22, Esprit
  - MERTEN 1M, , M-Pure, M-Smart
  - JUNG Aplus, Acreation, A500, AS500
  - BERKER B3, B7, S1
- Push Buttons adjustable for 1 or 2 button operation
- Built-in temperature sensor, RGB status LED indication
- Adjustable for button push length, NO or NC contact operation
- Short/long operation for KNX functions of lighting, scene control, shutter etc.
- Centered title block with cover film for customized marking
- Supporting ring included for installation, integrated bus coupling unit
- 3 years' warranty, matt/shiny finish available, white/ashy grey available

## KNX Multi-functional Thermostat, 55mm

CHTPB-04/00.1.00 CHTPB-04/00.2.00 CHTPB-04/00.2.01

### Function:

- 100% fits 55mm systems:
  - GIRA Standard 55, E2, E22, Esprit
  - MERTEN 1M, , M-Pure, M-Smart
  - JUNG Aplus, Acreation, A500, AS500
  - BERKER B3, B7, S1
- Support operation lock function
- Support HVAC control, AC control, VMC control, floor heating control
- Support all KNX push button functions
- Support 4 event group functions and 8 logic functions
- Built-in temperature sensor and 2-fold PT1000 interfaces
- 3 years' warranty, white/ashy grey available

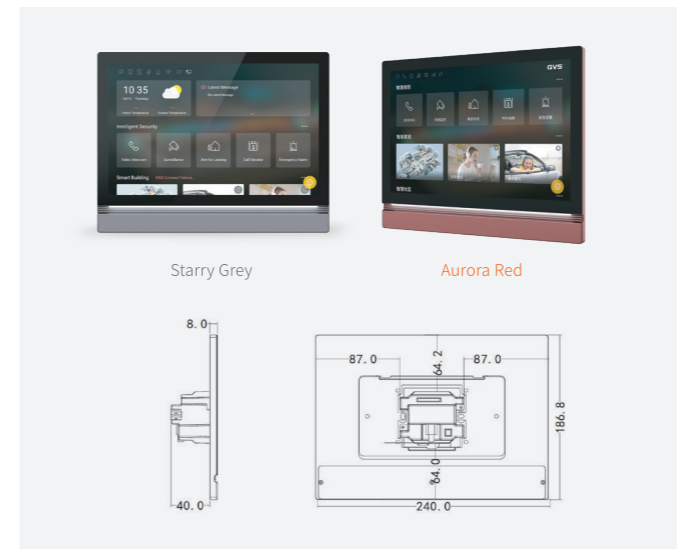

## KNX Smart Touch Z10

A-IS03 A-IS04

**NEW!**

### Function:

- Smart touch panel for both KNX and video intercom
- Aesthetic design with aluminum faceplate
- 10.1 inch colored IPS touch screen, 1280x800 resolution
- Support both map-view and list-view of all KNX functions
- Colored breathing light adjustable for color temp and brightness
- 8 time functions, 4 event group functions and 8 logic functions
- Switching, dimming, curtain control, HVAC and other KNX functions
- Support German standard twin-60mm wallbox installation
- Starry grey and aurora red available



## KNX Smart Touch V50

BV: CHTF-5.0/15.3.21 BH: CHTF-5.0/15.4.21  
 SV: CHTF-5.0/15.3.22 SH: CHTF-5.0/15.4.22

**NEW!**

### Function:

- Standard KNX Touch Panel with database & certificate
- 5" colored capacitive IPS touch screen, resolution 480\*854
- Up to 2 home pages and 15 function pages can be configured
- 16 time functions, 8 event group functions, 8 logic functions
- Password protection and customized screensaver
- Support switching, dimming, shutter control, HVAC control etc.
- Built-in temperature sensor
- Available with two colors silver & black, two types vertical & horizontal
- Supporting ring included for installation, perfectly fits 60mm/86mm wallbox

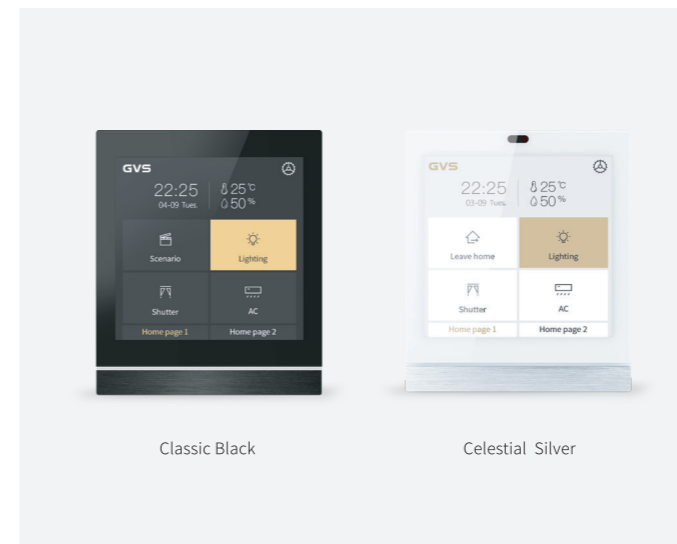

## KNX Smart Touch V40

CHTF-4.0/15.3.21 CHTF-4.0/15.3.22

**NEW!**

### Function:

- Standard KNX Touch Panel with database & certificate
- 4" colored capacitive IPS touch screen, resolution 480\*480
- Up to 2 home pages and 15 function pages can be configured
- 16 time functions, 8 event group functions, 8 logic functions
- Password protection and customized screensaver
- Support switching, dimming, shutter control, HVAC control etc.
- Built-in temperature sensor
- Available with two colors silver & black, two types vertical & horizontal
- Supporting ring included for installation which fits 60mm/86mm wallbox





**NEW!**

### KNX Multi-functional Actuator Mini, Flush Mounted

AMMAF-03/06.1

**Function:**

The multi-function actuator mini is meant to be used for simple or renovated KNX installations. Outputs of devices in this series can be flexibly set as switch, AC curtain, fan coil or valve control. Different output functions can be selected and configured via parameter setting in ETS.

- Switch output
- Fan control
- Curtain output
- Heating control
- Valve control
- Drive LED indicator
- Dry input detection

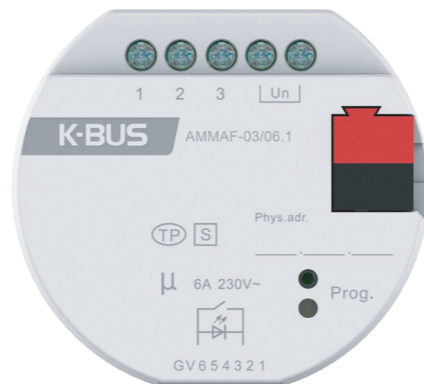

**NEW!**

### AIR 1 Server Gateway

BTAS-KNX/485.2

**Function:**







AIR 1 Server Gateway is the critical hardware for GVS remote control solution for KNX building automation. With AIR 1 Server properly connected and configured in a KNX installation, the user will be able to control all smart home functions remotely from either phone, tablet or PC. It is a perfect integrated solution for condo, residential houses and even commercial buildings.

- Standard KNX gateway for phone/tablet/PC APP control
- Easy configuration with PC software
- Support customized scenarios for end users
- Support cloud service with remote control of WIFI/3G/4G/5G

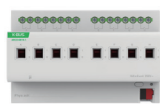
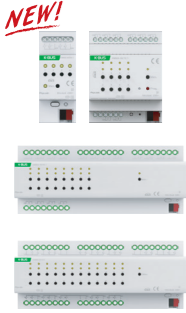

Picture	Name / Mode	Installation / Dimension	Function
<b>NEW!</b> 	<b>KNX Smart Touch Z10</b> A-IS03	Product size: 186.8 × 240 × 40mm Coupler size: fits 86 × 86 × 60mm	Smart touch panel for both KNX and video intercom Aesthetic design with aluminum faceplate 10.1 inch colored IPS touch screen, 1280x800 resolution Support both map-view and list-view of all KNX functions 8 time functions, 4 event group functions and 8 logic functions Switching, dimming, curtain control, HVAC and other KNX functions
	<b>KNX Smart Touch V10</b> CHTF-10.1/20.1.21 CHTF-10.1/20.1.24	206 × 305 × 28mm	10.1 inch color IPS touch screen, 1280*800 resolution Aesthetic design and aluminium made 8 time functions, 4 event group functions, 8 logic functions Switching, dimming, curtain control, HVAC and other KNX functions
<b>NEW!</b> 	<b>KNX Smart Touch V50</b> BV: CHTF-5.0/15.3.21 SV: CHTF-5.0/15.3.22 BH: CHTF-5.0/15.4.21 SH: CHTF-5.0/15.4.22	148 × 86 × 12.5mm	Standard KNX device with database & certificate 5" color capacitive IPS touch screen, resolution 480*854 16 time functions, 8 event group functions, 8 logic functions Password protection and customized screensaver Support switching, dimming, shutter control, HVAC control and other main KNX functions, built-in temperature sensor Supporting ring included for installation, fits 60mm/86mm wallbox
<b>NEW!</b> 	<b>KNX Smart Touch V40</b> CHTF-4/15.3.21 CHTF-4/15.3.22	90 × 86 × 32mm	Standard KNX Touch Panel with database & certificate 4" color capacitive IPS touch screen, resolution 480*480 Up to 2 home pages and 15 function pages can be configured 16 time functions, 8 event group functions, 8 logic functions Password protection and customized screensaver Support switching, dimming, shutter control, HVAC control etc. Supporting ring included for installation, perfectly fits 60mm/86mm wallbox
<b>NEW!</b> 	<b>KNX WALTZ Touch+ Pad</b> CHTFB-3.0/6.1.xx CHTFB-3.0/6.1.xx CHTFB-3.0/6.1.xx	115 × 86 × 34.7mm	IPS capacitive touch panel & mechanical button Aluminum frame and replaceable buttons (plastic/aluminum) Push Buttons adjustable for 1 or 2 button operation Built-in temperature sensor, RGB status LED indication Adjustable for button push length, NO or NC contact operation Short/long operation for KNX functions of lighting, scene control, shutter etc.
	<b>KNX Thermostatic Panel</b> CHTC-86/01.1.21 CHTC-86/01.1.22	86 × 86 × 11.6mm	Capacitive touch screen with high-contrast display Temperature, humidity setpoint, heating /cooling, fan speed mode and time displays Built-in temperature and humidity sensor Support PI control and 2-point control Temperature and humidity threshold functions, logical functions, timing functions Dry contact inputs and NTC temperature sensor
	<b>Push Button Sensor Plus, 1/2/3/4-gang</b> CHPLE-02/02.x.0y CHPLE-04/02.x.0y CHPLE-06/02.x.0y CHPLE-08/02.x.0y (x = 1, 2; y=0,1)	70.8 × 70.8 × 18.7mm	Switching and dimming Shutter control Value sending RGB and RGBW dimming Built-in Temperature sensor Logic functions Event Group function Matt and shiny finish LED indication, label instruction White and ashy grey available
	<b>KNX Multi-functional Thermostat, 55mm</b> CHTPB-04/00.1.00 CHTPB-04/00.2.00 CHTPB-04/00.2.01	70.8 × 70.8 × 19.3mm	Support operation lock function Support HVAC control, Air conditioning control, Floor heating and ventilation control Support push button functions: switch, dimming, curtain, scene, value send function Support 4 event group functions and 8 logic functions Built-in temperature sensor and 2-fold PT1000 interfaces

# Product List









Picture	Name / Mode	Installation / Dimension	Function	
	<b>KNX 6-Button Touch Switch Slim</b> CHTB-06/01.2.20 CHTB-06/01.2.22 CHTB-06/01.2.24	DIN rail 86 × 86 × 8.9mm	Switching and dimming Control of blinds and shutters Sending of values, e.g. water line, brightness	Recall and storage scene Bi-LED indication Glass touch control
	<b>KNX Switch Actuator, 4/8/12-Fold, 16A</b> (Normal) (Current Mnt) KA/R 0416.2 ARCD-04/16.2 KA/R 0816.2 ARCD-08/16.2 KA/R 1216.2 ARCD-12/16.2	DIN rail 90 × 72 × 64mm 90 × 144 × 64mm 90 × 216 × 64mm	Manual switch operation, switch status response Reaction after bus voltage failure and recovery Scene and preset control Logic operation with AND, OR, XOR, gate function Forced operation and safety function, threshold and time function NORMAL version and CURRENT MEASUREMENT version for option.	
	<b>KNX Multi-functional Actuator, 4/8/16/24-Fold Switch/Shutter/Fancoil</b> AMMA-04/06.1 AMMA-08/10.1 AMMA-16/10.1 AMMA-24/10.1	DIN rail 36 × 90 × 64mm 72 × 90 × 64mm 216 × 90 × 64mm	Multifunctional actuator with flexibility, one actuator for all functions, Max. 24 folds of switching output for lighting, socket etc. Max. 12 folds of AC/dry contact shutter/blinds control; Max. 6 folds of DC shutter/blinds control Max. 6 folds 3-level fan speed control 2/4-pipe valve system of both 3-point type and ON/OFF type	
	<b>KNX SCR Dimming Actuator, 2/4-Fold, 300w/ch</b> KA/D 0215.S.1 KA/D 0415.S.1	DIN rail 144 × 90 × 64mm 216 × 90 × 64mm	Switching Relative dimming Absolute dimming Status report, error report Up to 15 scenes setting Preset and set preset function	Staircase lighting function Support set Brightness value after bus voltage recovery Leading edge phase cut dimming Adjust dimming curve via manual buttons Manual operation and status indication
	<b>KNX 1-10V Dimming Actuator</b> ADTV 04/16.1	DIN rail 90 × 144 × 64mm	Switching Relative and absolute dimming Status report, error report Scene and preset function	Staircase lighting function Preset a Brightness value after bus voltage recovery Passive DC 0/1-10V drive mode Manual operation and status indication
	<b>KNX LED Dimming Actuator, 4-Fold, 4A</b> ADLD-04/03.1	DIN rail 90 × 72 × 64mm	Switching Relative and absolute dimming Status report, error report Scene and preset function	Staircase lighting function Preset a Brightness value after bus voltage recovery Constant voltage drive mode Manual operation and status indication
	<b>KNX Fan Coil Controller, 0-10V</b> AFVFT-07/10.1	DIN rail 90 × 72 × 64mm	Support 2/4 pipes HVAC system Support 2 wire or 0-10V valve type Support 2-point control or PI control methods for local Support relay/0-10V drive fan, 3-level fan speed	Standby/comfort/night/protect mode Channels can be reused as switch output Manual operation and LED indication Support 3-wire PT1000 sensor
	<b>KNX Room Controller V3.0</b> AMRP-41/05.3	DIN rail 216 × 90 × 64mm	Dry contact and binary inputs LED indications Switch/shutter outputs Traic dimming	Fan coil output 0-10V dimming Logic, Time and Scene group functions Support KNXnet/IP tunneling/ routing
	<b>KNX Multi-functional ActuatorMini, Flush Mounted</b> AMMAF-03/06.1	Flush Mounted 53 × 48.3 × 23.5mm	Switch output Curtain output Valve control Dry input detection	Fan control Heating control Drive LED indicator

# Product List

Picture	Name / Mode	Installation / Dimension	Function	
	<b>KNX Air Quality Sensor V2</b> CSAQI-06/00.1.00 CSAQI-06/00.1.01	86 × 86 × 48.3mm	PM2.5, PM10, VOC,AQI,CO2 detection and display Temp,humidity detection and display Warning for value detection Heating or cooling control output	Built-in ventilation controller Logic control functions VOC,CO2, alarm output AQI,Humidity level alarm output
	<b>Presence Sensor with Constant Lighting</b> CSBPC-02/00.1	Ceiling-Mounted Wall-mounted 88 × 63mm	Illumination measure: 0 lux~65535 lux Movement detector range: mounting height * 2, max. diameter is 8m Logic (AND, OR, XOR) function; support master-slave interworking Output with 3 data types, the output values can be sent cyclically Illumination/movement detection disabling and logic disabling	
	<b>Motion and Brightness Sensor-8M</b> CSBP-02/00.2	Ceiling-Mounted 90 × 64 × 36mm	Motion or Presence detector can be integrated control with ambient brightness Sequence operation for the motion Motion or Presence detector can be integrated Brightness and motion detection Master-slave detector function	
	<b>KNX Gateway for IR,Ceiling,V2</b> BTIRC-01/00.2	Ceiling-Mounted 91 × 82 × 76mm	360 degree full direction transmitting Support multi-emitting and delayed-emitting Installation height is max.4m, the transmitting distance is max.3m (radius) Support Universal IR control, up to 30 IR code Support Air-condition control, up to 266 IR codes	
	<b>KNX Gateway for IR Flush mounted,2-Fold</b> BTIRF-02/00.2	80/60mm wall box Φ53 × 23.5mm	2 channels, flush mounted Support multi-emitting and delayed-emitting The transmitting distance is max.2m Support Universal IR control, up to 30 IR code Support Air-condition control, up to 266 IR codes Supports current detection, up to 10A	
	<b>IR Learner</b> BTIL-01/00.2	18 × 20 × 77mm	Capability of learning over 95% remote control units in the market USB to communicate with PC, easy to learn and store IR codes from remote	
	<b>KNX Universal Interface, 4-Fold</b> KI/U0401.1	46 × 46 × 11.7mm	Switching and dimming Control of blinds and shutters Sending of values, e.g. water line, brightness Recall and storage scene	Switching sequence Counter Multiple operation LED indication output
	<b>KNX Universal Interface, 4/8-Fold</b> CTUI-04/04.1 CTUI-08/08.1	46 × 46 × 11.7mm	Switching and dimming Control of blinds and shutters Sending of values, e.g. water line, brightness Recall and storage scene 12V LED indication	Switching sequence Counter Multiple operation LED indication output
	<b>KNX Binary Input for floating contact, 4/8/16-Fold</b> CTBIF-04/00.1 CTBIF-08/00.1 CTBIF-16/00.1	DIN rail 36 × 90 × 64mm 72 × 90 × 64mm	Switching and dimming Shutter function Value sending Recall and storage scene Shift register function	RGB and RGBW dimming Multiple operation Delay mode logic functions Event Group function
	<b>KNX Binary Input, 4-Fold</b> CTBI-04/00.1	DIN rail 90 × 36 × 64mm	Switching and dimming Control of blinds and shutters Sending of values, e.g. water line, brightness Recall and storage scene	Switching sequence Multiple operation LED indication Manual operation



# Product List

Picture	Name / Model	Installation / Dimension	Function
	<b>KNX/IP Interface</b> BNIP-00/00.1	DIN rail 36 × 90 × 64mm	Support KNX/IP Tunneling Can be used as the programming interface for other KNX devices Support UDP telegram and port number 3671 Support up to 5 KNX IP client connections
	<b>KNX Gateway for RS485/RS232</b> BTPG-04/03.1	DIN rail 72 × 90 × 64mm	Support the conversion between RS232 and KNX telegram Support the conversion between RS485 and KNX telegram Support Modbus master and slave for system integration Support Daikin air conditioner in Modbus RTU mode
<b>NEW!</b> 	<b>KNX/DALI Gateway, 1-Fold / 2-Fold</b> BTDG-01/64.1 BTDG-02/64.1	DIN rail 90 × 72 × 64mm	Two-channel gateway with broadcast function 64 DALI devices per channel for single device, 32 DALI group control per channel Various status feedback, e.g. switch, brightness, operation hours etc. Fault detection of lamps and ballasts for DALI devices Monitoring DALI bus voltage, DALI bus current and DALI bus short circuit status
<b>NEW!</b> 	<b>Air1 Server Gateway</b> BTAS-KNX/485.2	DIN rail 108 × 90 × 64mm	Standard KNX gateway for phone/tablet APP connection Support standard Tuya wireless protocol devices Support customized scenarios for end users Support cloud service with remote control of WIFI/3G/4G/5G
	<b>AirHome Remote Pro</b> (APP for remote control)	iOS download: iOS Appstore  Android download: Googleplay Huawei Galaxy Xiaomi Market GVS website	Standard KNX gateway for phone/tablet/PC APP control Easy configuration with PC software Support customized scenarios for end users Support cloud service with remote control of WIFI/3G/4G/5G
	<b>KNX USB Interface</b> BNUS-00/00.1	77 × 20 × 18mm	An interface between PC and KNX bus to configure, parameterize and commission KNX bus
	<b>KNX IP Router</b> BNIPR-00/00.1	DIN rail 36 × 90 × 71mm	Support 4 client connections Support KNXnet/IP, ARP, ICMP, IGMP, HTTP, UPnP, UDP/IP, TCP/IP, DHCP and Auto IP Can be used as line/backbone coupler to couple ethernet and KNX-TP lines Support filter table routing function Can be used as the programming interface
	<b>KNX Line Coupler</b> BNLC-00/00.1	DIN rail 36 × 90 × 71mm	As a KNX line coupler, it connects main line to backbone line, or line to main line As a KNX line repeater, it extends the length of bus line and the number of KNX devices
	<b>KNX Power Supply</b> KP/D30.640.1	DIN rail 90 × 108 × 64mm	Input voltage: 95V ~255 Vac, 47~63Hz Sustained short-circuit current: < 1.3 A Rated current: 640mA, short-circuit-proof  1 fold auxiliary voltage output Output status display Reset function

# Product Series

Video Intercom System  
P. 013 - P. 023



## IP Video Intercom System Briefing



## H Series Video Intercom System

The H Series system is a full digital video intercom solution based on TCP/IP protocol. It supports digital video intercom, information broadcast, multi-channel calling, room-to-room intercom, alarm, home automation etc. The solution provides clear and fluent video intercom service and security alarm, which enhances the community security.

The system could be defined and applied to different buildings with a wide-range functions, meanwhile, supporting both 24V PoE power and 48V standard PoE also makes the system more flexible for installations of all kinds.

## H Series Video Intercom Topology Diagram

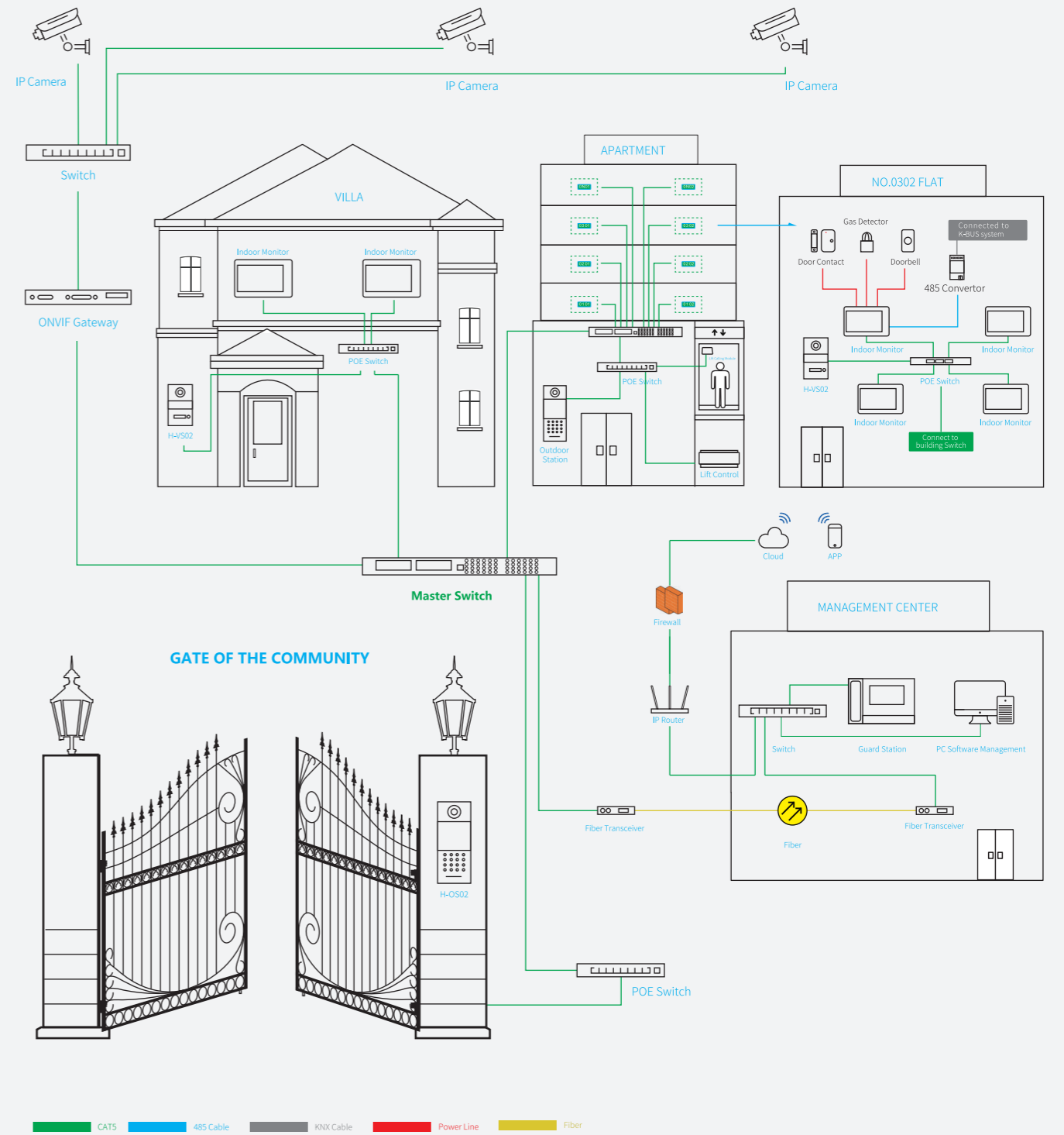

# TCP/IP Video Intercom

## 7" Touch Outdoor Station Binocular

H-OS16

### Function:

- 2 megapixel HD camera
- Aesthetic design with aluminum faceplate
- Face recognition with approximate detection
- 7" LCD Display with sensitive touch panel
- Door status detection
- Fill-in light with high luminance LED
- Support IC Card
- Support normal-close /normal-open
- Support standard 48V POE



**NEW!**

## 4.3" IP Outdoor Station

H-OS09

### Function:

- 2 megapixel HD camera
- Aesthetic design with aluminum faceplate
- Face recognition with approximate detection
- 4.3" LCD Display with sensitive touch panel
- View angle 123°
- Door status detection
- Fill-in light with high luminance LED
- Support IC Card
- Support normal-close /normal-open
- Support standard 48V POE
- Random password unlock and QR code unlock \*

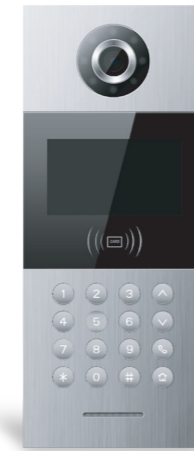

- Cloud intercom APP is required

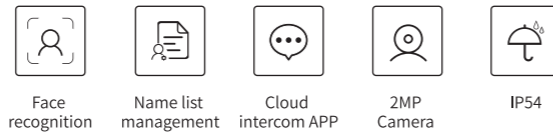

## Mini Outdoor Station

H-VS02

### Function:

- Aluminum panel
- Working voltage: DC 24V ( support POE )
- Support IC card
- Support intercom function
- Support tamper alarm
- IPX4 waterproof



# TCP/IP Video Intercom

## 10.1 " Indoor Monitor

- 10.1" glass capacitive touch screen
- Support optional 24V / 48V POE
- Automatic photo capture
- Support intercom function
- Support call diverting
- Easy GUI customization
- Support KNX home automation connection



○ H-IS06 ● H-IS19

## 7 " Indoor Monitor

- Working voltage: optional 24V / 48V POE
- 7" capacitive touch with advanced GUI
- Automatic photo capture
- Support intercom function
- Alarm settings with 8 defense zones
- Save up to 6 CCTV cameras in one monitor
- Support KNX home automation connection



○ H-IS07 ● H-IS10

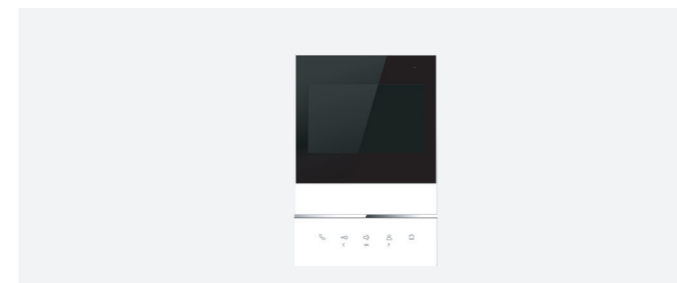

## 4.3 " Indoor Monitor

○ H-IS02

- Working voltage: DC 24V (support 24V POE)
- Protocol: Standard TCP/IP
- 4.3" TFT with advanced display effect
- Automatic photo capture
- Support intercom function
- Sensitive touch key, cost-effective version



## Audio Phone

○ H-IS14

- SOS Alarm
- Support multiple telephone
- apartment
- Intercom between apartment & Guard Unit
- Ringtone/talking volume adjustable



● H-CG01

## IP Camera Gateway

- Support ONVIF IP camera
- Support up to 255 CCTV cameras
- Support 5 users' surveillance at the same time



○ H-LC02

## Lift Control Module

- Working Voltage: DC 24V (support POE)
- RS485 protocol output



○ H-LC01

## Lift Calling Module

- Working Voltage: DC 24V (support POE)
- Calling from lift to Guard Unit



● H-CR01

## Access Control Card Reader

- Max 10,000 resident IC / ID cards
- Support public password unlock
- Door status detection and timeout alarm



# TCP/IP Video Intercom

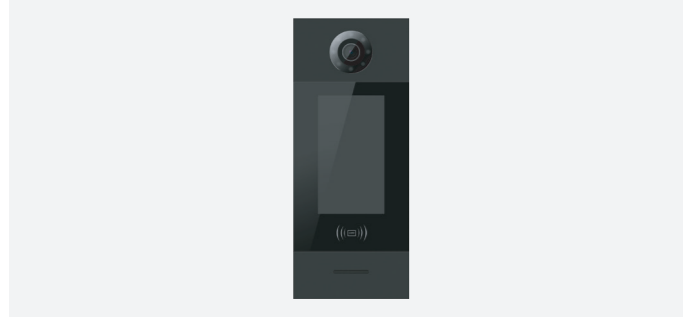

● H-OS06

## 7" IP Outdoor Station

- 2 megapixel HD camera
- Aesthetic design with aluminum faceplate
- Face recognition with approximate detection
- 7" LCD Display with sensitive touch panel
- View angle 123°
- Door status detection
- Fill-in light with high luminance LED
- Support IC Card
- Support normal-close /normal-open
- Support standard 48V POE
- Random password unlock and QR code unlock \*
- Cloud intercom APP is required



● A-IS03

## KNX Smart Touch Z10

- Smart touch panel for both KNX and video intercom
- Aesthetic design with aluminum faceplate
- 10.1 inch colored IPS touch screen, 1280x800 resolution
- Support both map-view and list-view of all KNX functions
- Support optional 48V POE power & auxiliary 24V power
- Automatic photo capture, easy GUI customization
- Support intercom function
- Support call diverting



○ H-IS16W ● H-IS16B

## 7" Indoor Monitor

- Working voltage: optional 24V/48V POE
- 7" capacitive touch with advanced GUI
- Automatic photo capture
- Support intercom function
- Alarm settings with 8 defense zones
- Save up to 6 CCTV cameras in one monitor
- Support KNX home automation connection



○ H-GU02

## 10" Guard Unit

- Support max. 255 IP cameras
- Card management function
- Alarm and SOS alert
- Support ONE-KEY (all) door opening
- PC Management system included

# Two-wire Video Intercom



## Two-Wire video door phone system

The **T Series** 2-wire analog video door phone solution is a stable & economic system which supports both audio/video intercom, access control, CCTV surveillance and all other intercom functions, capacity of the system is excellent with:

- Up to 128 indoor monitors
- Up to 3 outdoor stations in one system
- Up to 160 meters from door station to the last monitor

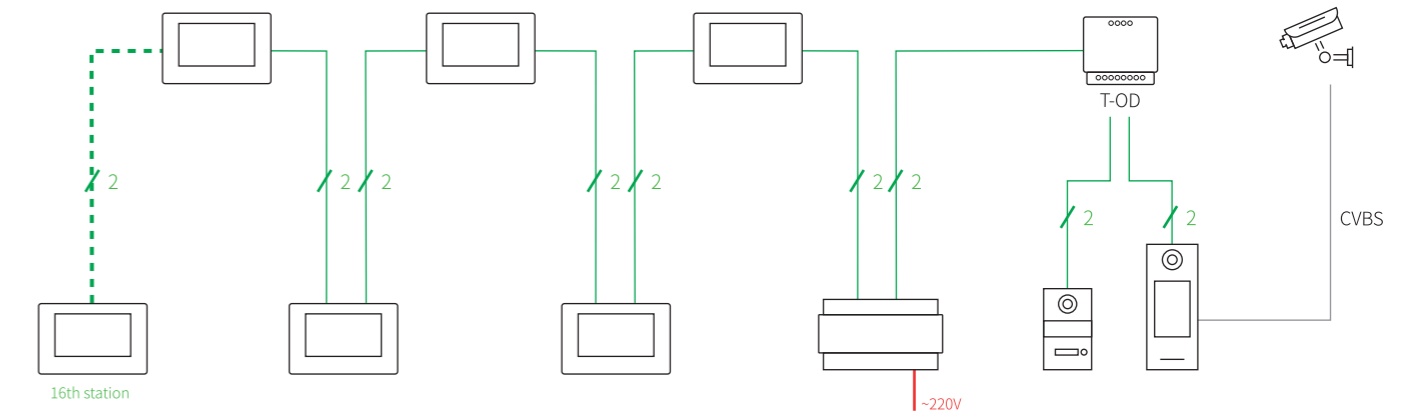

Serial connection for single house/villa

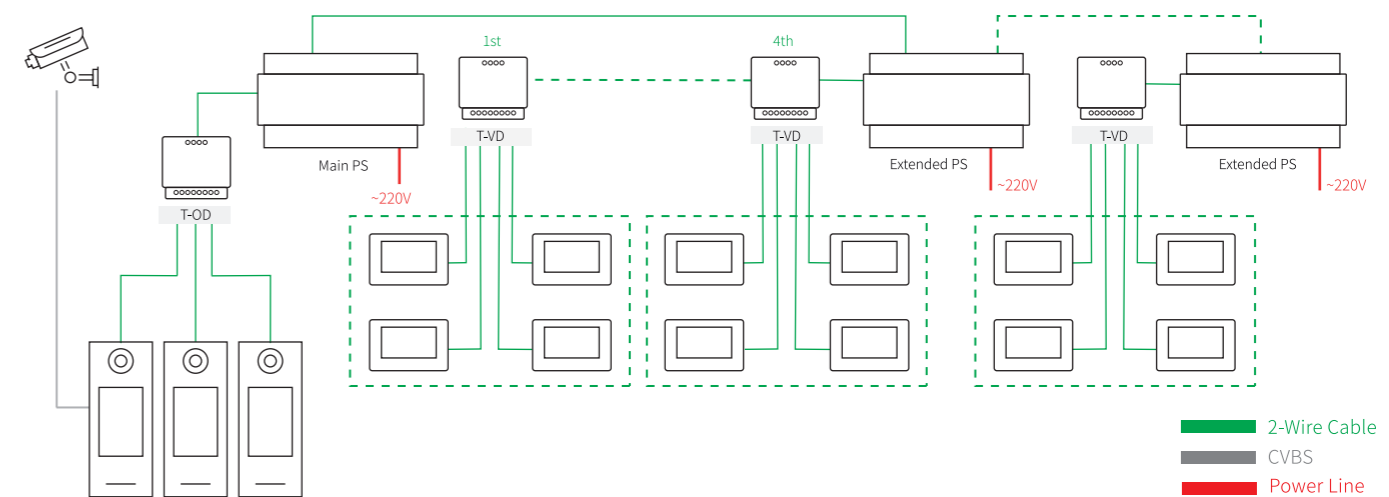

■ 2-Wire Cable  
■ CVBS  
■ Power Line

Star connection for apartment



# Two-wire Video Intercom

## 7" 2-wire Touch Outdoor Station

T-OS02

**Function:**

- 7" capacitive touch screen design
- Aesthetic design with Aluminium panel
- Support analogue camera surveillance by built-in interface
- Support 2-wire centralized power supply
- Flexible GUI customization
- Name list program through 2-wire bus
- IC Card reader
- Main page can be configured as keypad or name list type



## 2.8" Keypad Outdoor Station

T-OS07

**Function:**

- Classic Aluminium panel
- Support analogue camera surveillance by built-in interface
- Support 2-wire centralized power supply
- Support Name list
- IC Card reader

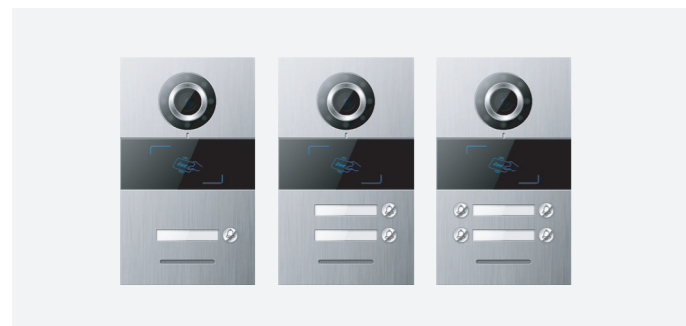

○ T-OS01/T-OS03/T-OS04

### Mini Outdoor Station

- IC card reader
- Support unlock button interface
- Support white led light supplement
- IPX4 waterproof
- Flush mounted installation

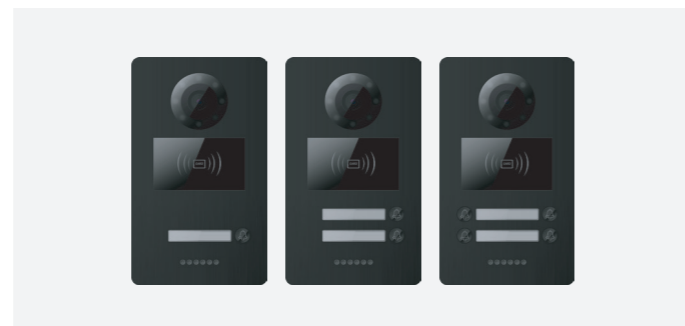

● T-OS05/T-OS08/T-OS09

### Mini Outdoor Station

- IC card reader
- Support unlock button interface
- Support white led light supplement
- IPX4 waterproof
- Flush mounted installation

# Two-wire Video Intercom

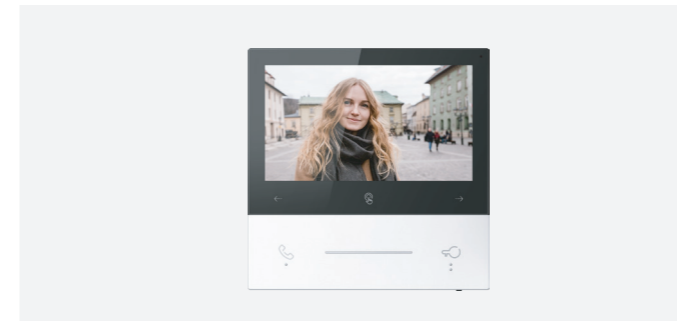

○ T-IS11

### 7" Indoor Monitor

- 7" glass touch screen and nice touch keys
- Video intercom, monitoring and unlock
- Optional with touch panel or touch key version
- Built-in power supply which saves budget
- Max.4 indoor monitors in one apartment
- Support TF card extension (2-32G)
- Support photo capture and video record
- Can be reused as guard unit when addressed as 200\*
- Built-in multi-languages

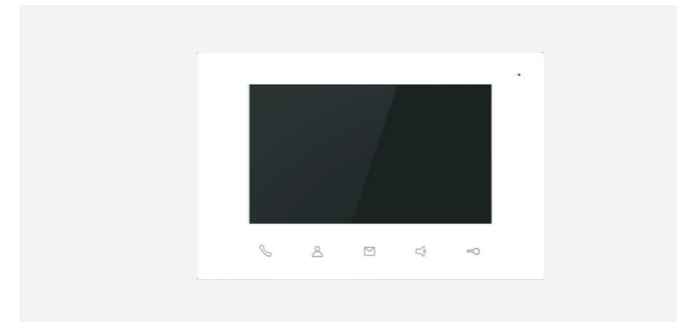

○ T-IS01

### 7" Indoor Monitor

- 7" glass touch screen and nice touch keys
- Video intercom, monitoring and unlock
- Max.4 indoor monitors in one apartment
- Support TF card extension (2-32G)
- Support photo capture and video record
- Can be reused as guard unit when addressed as 200\*
- Built-in multi-languages
- Support intercom

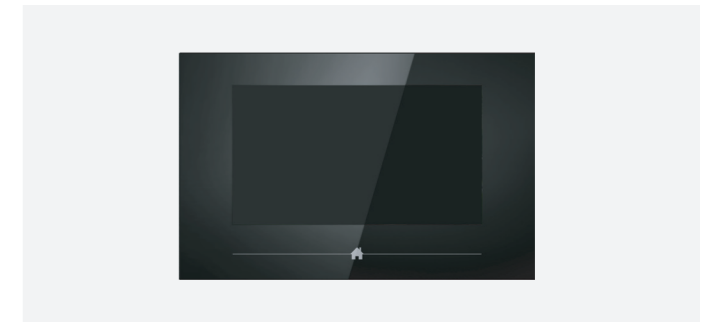

○ T-IS06

### 7" Indoor Monitor

- 7" glass touch screen
- Video intercom, monitoring and unlock
- Max.4 indoor monitors in one apartment
- Support TF card extension (2-32G)
- Support photo capture and video record
- Can be reused as guard unit when addressed as 200\*
- Built-in multi-languages
- Support intercom

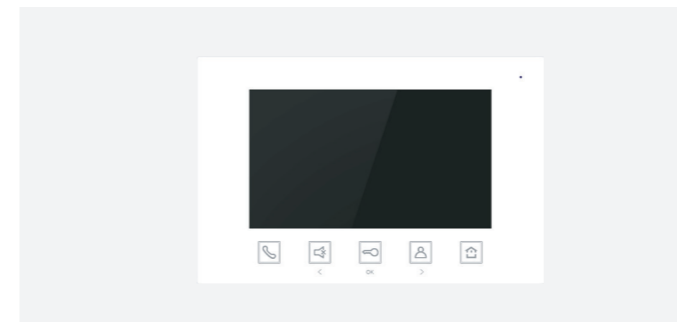

○ T-IS05

### 7" Indoor Monitor Lite

- 7" monitor with touch key with OSD
- Video intercom, monitoring and unlock
- Max.4 indoor monitors in one apartment
- Support intercom
- Can be reused as guard unit when addressed as 200\*

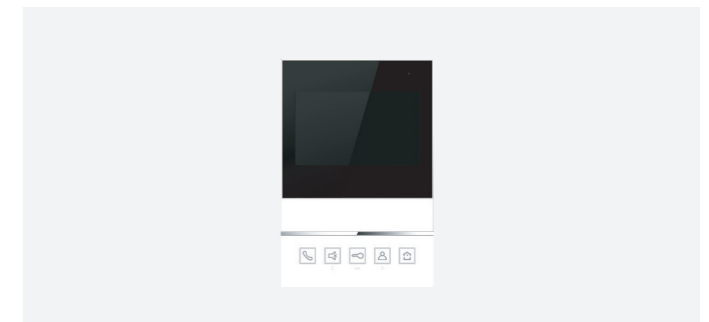

○ T-IS04

### 4.3" Indoor Monitor Lite

- 4.3" monitor with touch key design
- Video intercom, monitoring and unlock
- Max.4 indoor monitors in one apartment
- Can be reused as guard unit when addressed as 200\*
- Support intercom

# Two-wire Video Intercom



T-VD

### Monitor Distributor

- Connects up to 4 indoor monitors
- \* Necessary in a star connection topology to separate 4 monitors in one apartment (details please refer to topology diagram)



T-OD

### Door Station Distributor

- Connects up to 3 outdoor stations
- \* Necessary when there are more than 2 door stations in one system(details please refer to topology diagram)



T-RA

### Relay Control Module

- Relay for a second door lock
- Alternative for LED light controlling



T-CI

### Analogue Camera Interface

- For adding extra analogue cameras
- 3 channels available



T-Adaptor

### Name List Tool

- For configuration of the name list in 7" Touch Outdoor Station



T-PS01-C

### Power Supply

- Working voltage : AC100V~240V
- Output voltage : DC30V
- Support system power management
- Single power supply powers
- 32 indoor monitors maximum



T-PS02

### Extended Power Supply

- Working voltage : AC100V~240V
- Output voltage : DC30V
- Supports max 16 indoor monitors for signal amplification



Plug & Play



Gift Package



Security Assured



Pro & Lite Version

**NEW!**

## Way-2-Easy Kit Pro

2-wire intercom kit

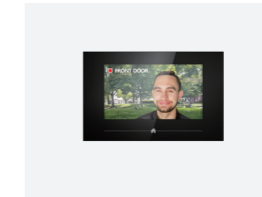

### 7" Indoor Monitor

- 7" colored TFT display
- Full capacitive touch panel
- Elegant design



### Outdoor Station

- IP54 · IK07
- Max. 2 apartments supported
- Easy and secured surface-mounting



### Power supply

- Standar din-rail installation
- AC 100-240V, 50-60Hz, 600mA
- Support max 6 devices

**NEW!**

## Way-2-Easy Kit Lite

2-wire intercom kit

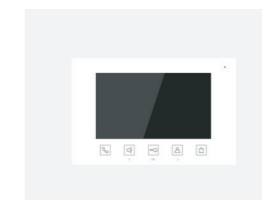

### 7" Indoor Monitor

- 7" colored TFT display
- Touch key
- Elegant design



### Outdoor Station

- IP54 · IK07
- Max. 2 apartments supported
- Easy and secured surface-mounting



### Power supply

- Standar din-rail installation
- AC 100-240V, 50-60Hz, 600mA
- Support max 6 devices

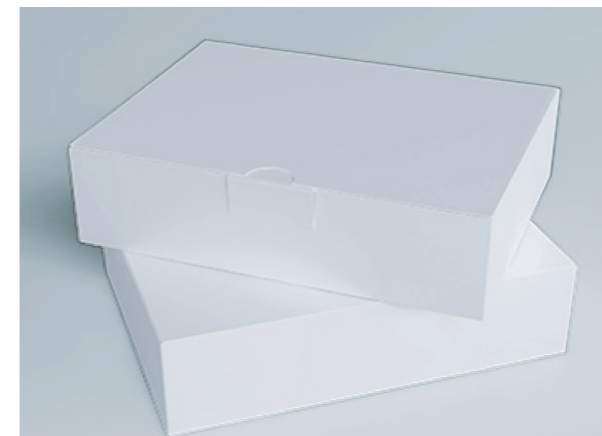

Plug & Play



Gift Package



Security Assured



Pro & Lite Version

## Monitor Selection Table

	H-IS14	H-IS02	H-IS07	H-IS11	H-IS16	H-IS06	H-IS19	T-IS06	T-IS04	T-IS05	T-IS01	T-IS07	T-IS11
Screen size	/	4.3"	7"	7"	7"	10.1"	10.1"	/	4.3"	7"	7"	7"	7"
Color	White	White/Black	White/Black	Silver/Black	White/Black	Golden/Silver	Black	White	Black	White	White	White/Black	White/Grey
Power supply mode	24V PoE	24V PoE	24V/48V PoE	24V/48V PoE	48V POE	24V/48V PoE	48V POE	2 wire PS 3.0V	2 wire PS 3.0V	2 wire PS 3.0V	2 wire PS 3.0V	2 wire PS 3.0V	2 wire PS 3.0V
Touch screen	/	/	Yes	Yes	Yes	Yes	Yes	/	/	/	Yes	Yes	Yes
Picture memory	/	Yes	Yes	Yes	Yes	Yes	Yes	/	/	/	Yes	Yes	Yes
Button type	Mechanical button	Touch key	Touch panel	Touch panel	Touch panel	Touch panel	Touch panel	Mechanical button	Touch key	Touch key	Touch panel	Touch panel	Touch panel
Dimension WxHxD(mm)	209.9x79.9x52.8	180x123x20.5	220x140x17.5	200x130x14.9	220x140x17.5	305x206x28	305x206x28	209.9x79.9x52.8	180x120x19.5	220x140x24	220x140x24	220x140x24	179.61x179.61x25
Technology	IP												
Number of wires	Non-polarised Two-wire												
Max.distance(meters)	2												
Guard unit	160												
Max.number of apartments	Yes												
Extension per apartment	≈ 2 million (max.coding.address)												
	128												
	4												

## Featured Project

Classic GVS project worldwide  
P. 025 - P. 029

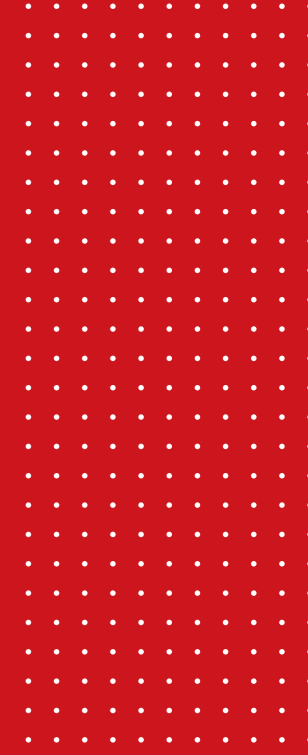



# Featured Project



## Daxing International Airport

- 📍 Location : Beijing, China
- 🏢 Project Type : Airport
- 📏 Size : Departure Lounge & Landing Field

Beijing Daxing International Airport, as one of the TOP 3 airports globally, has finished its last phase of installation in mid 2019. The airport is famous for its unique and elegant design as well as its huge capacity for passengers, it's praised as one of "The New Seven Wonders Worldwide" by British Guardian. GVS, as the leader of the smart building in China, has participated in the airport automation in its decoration phase and successfully installed thousands of KNX components in the brand new airport to enable smart lighting control, HVAC control etc. Till today, Daxing International Airport has become the biggest and most successful KNX airport project.

## Guangzhou Metro System

- 📍 Location : Guangzhou, China
- 🏢 Project Type : Metro Station
- 📏 Size : 42 stations lighting control

GVS has won the KNX automation part in the latest THREE Guangzhou new lines: line #13, #14, #21 with 42 stations. The whole project has successfully been installed in 2018 and handedover to the civic operation office. With a huge number and extreme length, the Guangzhou Metro system now becomes the largest KNX automation system in the category of metro system worldwide. Besides, GVS is also working closely with metro/train station systems in other major cities like Shenzhen, Ji'nan, Zhangjiajie, Foshan etc.

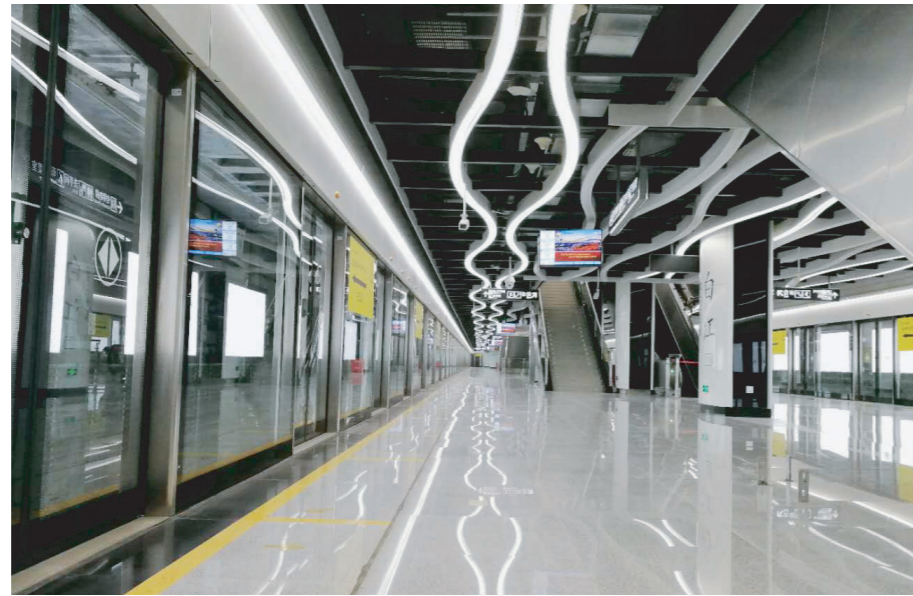

**Hangzhou International Airport**  
Hangzhou, China

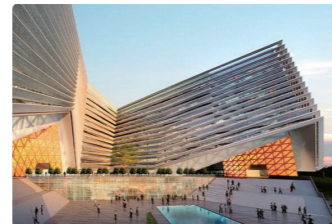

**Alibaba Headquarter,**  
Hangzhou, China



**Guangzhou Metro,**  
Guangzhou, China

# Featured Project

**Wuxi Spring Garden**  
Wuxi, China



**Qianjing Garden**  
Shanghai, China



**Haoyuan Apartment**  
Xinjiang, China



**Haoyuan Community**  
Jinan, China



## Scandinavia Luxury Apartment

- 📍 Location: Jakarta, Indonesia
- 🏢 Project Type: Commercial-Residential Complex
- 📏 Size: 1000+ apartments

With the help of GVS smart community technology, Scandinavia Apartment becomes one of the most significant building in Jakarta city. The Commercial-Residential complex solves the living problem, while GVS smart community solution improves the living quality. Over 2,000 GVS video intercom & KNX smart home devices contributed a lot in the automation & security of the building in 2018.

## Smart Istanbul Residential Community

- 📍 Location: Istanbul, Turkey
- 🏢 Project Type: Residential
- 📏 Size: 3000 Residence

As the biggest residential community in the capital city, the best smart community solution is required for a better living and management. By using GVS IP video intercom system, it offers a stable & reliable solution for the video intercom among visitors, residence and security guard. What's more, it also makes this huge community closely connected & smarter with features of alarm, surveillance, face recognition, remote APPs, lift control, QR code unlock etc.





## Featured Project

**Résidence Marcel Marlier**  
Tournai, Belgium



**Yun Shan Shi Yi Community**  
Guangzhou, China



**Seri Pilmoor 110 Villas**  
Kuala Lumpur, Malaysia



**HuaYuan · Dayi Resort**  
Guangzhou, China



## JIN MAO Palace Condominium

- Location : Guangzhou, China
- Project Type : high-end condominium
- Size : 2400+ condo apartments

CHINA JIN MAO GROUP, as a Fortune 500 Company, is one of the biggest real estate and hotel investment group company in China. As s strategic partner of JIN MAO group, GVS has successfully helped the real estate giant in its condominium projects in Shenzhen, Guangzhou, Fuzhou, Xianmen and other big cities in China. With a combination of GVS tailored switches and solutions based on KNX home and building automation system, the high-end condos nowadays produced by JIN MAO are leading the real estate industry with smart home conception.

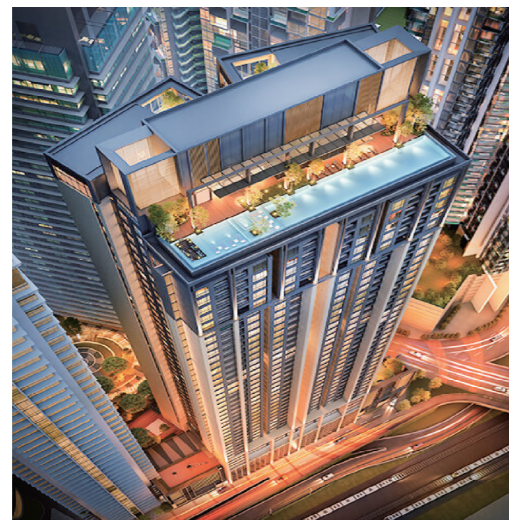

## KL Eco City

- Location : Kuala Lumpur, Malaysia
- Project Type : Commercial-Residential Complex
- Size : 500+ apartments

As special commercial & residential complex, the KL Eco City in Malaysia has planned quite environmentally friendly systems, among which KNX is one of the most important system. Over a thousand and half pcs of KNX devices from GVS have contributed to the automation of the building, helping the project win the first GBI Gold Medal in Malaysia.

## Featured Project



## Grand Hyatt Athens

- Location : Athens, Greece
- Project Type : 5-Star Hotel
- Size : 300 guest rooms

Grand Hyatt Greece, as a 5-star luxurious hotel under Hyatt Hotel Group, reopened in 2018 after a systematic renovation with GVS KNX hotel system. The hotel, as a landmark of Athens, started to accept its customers since 1983 and stopped in 2010 because of the crisis. Based on the latest KNX technology, GVS helped the hotel in its automation part and finally turned the hotel to smarter and more comfortable one with its advanced KNX technology.

## Fairmont Marina Residences

- Location: Abu Dhabi, UAE
- Project Type: hotel residences
- Size: 249 serviced apartments

Fairmont Marina Residences, a 39-storey Arabian themed skyscraper which resembles the hotel located at the top of Dubai' s Palm Jumeirah, is the first Fairmont-branded hotel residences in the UAE, it' s part of the 563-room Fairmont Marina Resort in Abu Dhabi. GVS, by actively participating in the hotel decoration process of the project, has worked with a few other KNX brands and successfully equipped the hotel residences with the latest smart hotel technology.



**InterContinental Hotel**  
Wuxi, China



**Falkensteiner Schlosshotel**  
Austria



**Herbarium Hotel & SpA**  
Gmina Gąsawa, Poland

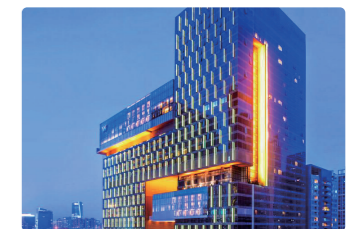

**W Hotel**  
Guangzhou, China



**Beijing No. 1 Social  
Warefare Home**  
Beijing, China



**Evergrande Group  
Healthyland**  
Sanya, China



**The General Hospital of the  
People's Liberation Army**  
Beijing, China



**Vanke Tianjin Yiyuan  
Elderly Care Center**  
Tianjin, China



## Ji'nan Maternal and Child Healthcare Hospital

- 📍 Location : Ji'nan, China
- 🏢 Project Type : Smart Hospital
- 📏 Size : 50+ pediatrics patient rooms

Ji'nan Maternal and Child Healthcare Hospital is a famous First-class Hospital at Grade Three for women and children, the hospital is an integration for healthcare, scientific research and medical teaching, with its inpatient and out patient amount ranking first in Shandong Province.

In October 2018, it became the 1st smart hospital under help of GVS team by installing the very first Smart Pediatrics Ward in Shandong Province with a total number of 50+ patient rooms. The smart ward has a variety of new functions such as visitor management system, smart information display, smart clinical data collection system, and all functions are transmitted by different protocols like LoRa, BLE, RFID, WiFi and KNX. As an excellent IoT service provider, GVS successfully integrated all protocols and made the hospital a smart and modern one.

### How it works for a smart hospital?

